

Part number description

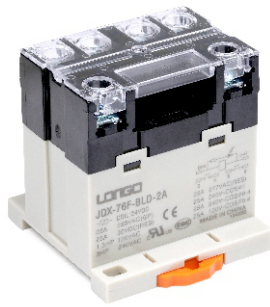

JQX-76F-BLD-2A



JQX-76F-TU-2A

JQX-76F-□ □ □ □ □

- Terminal shape _____
- T: Quick connect terminals (#250)
- B: Screw terminals
- P: PCB terminals
- BL: Screw terminals + LED
- Bolt terminal+protective cover+LED
- Mounting Construction _____
- Blank: E-bracket
- U : Upper bracket
- D: DIN track
- Contact form _____
- 1A:normally open
- 2A:normally open
- Coil voltage _____
- 6~220VDC
- 6~400VAC
- Special options _____

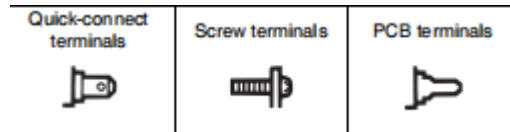

Specification

		Contact form	
		1A	2A
Contact	Rated load	Resistive (AC-1)	277VAC,30A
		Motor (AC-15)	1.5HP,120VAC 3HP,240VAC
	Operating power(Resistive)		8310VA
	Contact resistance(Initial)		≤50mΩ
	Material		Ag alloy
	Electrical endurance		≥10 ⁷ cycles(18000 Ops/h)
	Mechanical endurance		≥5×10 ⁶ cycles(18000 Ops/h)
Pick-up voltage (23℃)		AC,DC:≤75%Rated voltage	
Drop-out voltage (23℃)		AC,DC:≥15%Rated voltage	
Max. Allowed voltage(at 25℃)		110%Rated voltage	
Insulation resistance		≥100MΩ(500VDC)	
Coil power consumption	DC(W)	1.9	
	AC(VA)	2.5	
Operate time(at nominal voltage)		≤30ms	
Release time(at nominal voltage)		≤30ms	
Initial dielectric strength	Between contacts	2000VAC/1min (Leakage current 1 mA)	
	Between poles	2000VAC/1min (Leakage current 1 mA)	
	Between contact and coil	4000VAC/1min (Leakage current 1 mA)	
Ambient temperature		-25~+55℃	
Humidity		35%~85%RH	
Atmospheric Pressure		86~106KPa	
Shock resistance		10G (Half a wave of pulses of sine:11ms)	
Vibration resistance		10~55Hz Dual amplitude:1.5mm	
Install model		Quick connect terminals, Screw terminals, PCB terminals, DIN track	
Weight		Plug-in type Approx.90g,Bolt type Approx.120g	
Matched relay socket		P76-F06 (Matching plug-in type)	
Equivalent Product	OMRON	G7L-1A	G7L-2A

Coil Specifications(23°C)

Rated voltage V.DC	6	12	24	48	100	110	220
Coil resistance Ω ($\pm 10\%$)	18.9	75	303	1220	5260	6360	25474
Rated voltage V.AC	6	12	24	48	100-120	200-240	380-400
Coil resistance Ω ($\pm 10\%$)	17	65	275	1100	5200	21000	62650

Dimension.Bottom View (mm)

JQX-76F-P-1A/2A

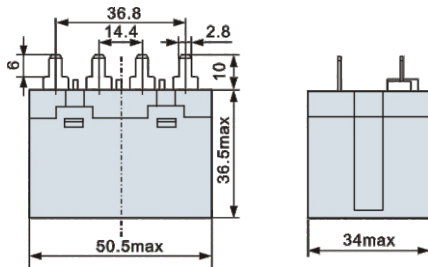

JQX-76F-BU-1A/2A

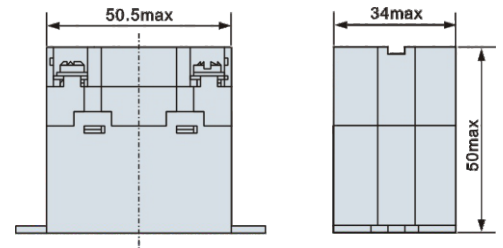

JQX-76F-TU-1A/2A

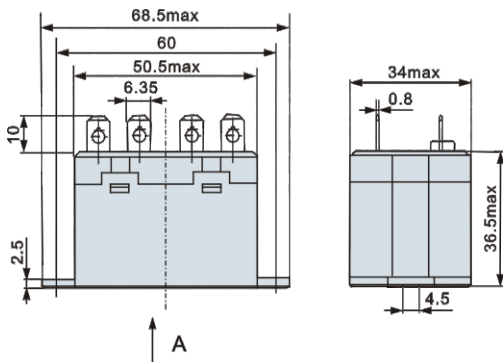

JQX-76F-TD-1A/2A

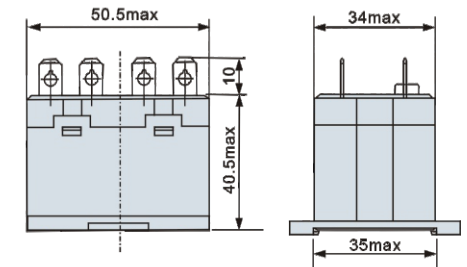

JQX-76F-TK-1A/2A

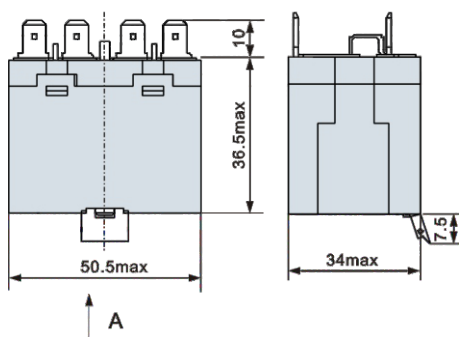

JQX-76F-BD-1A/2A

