

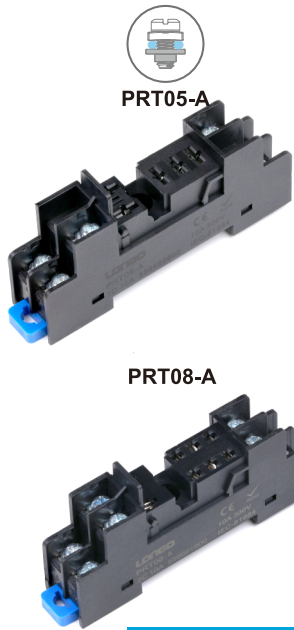

Characteristics



Type			PRT05-A	PRT08-A
Nominal load	Current	A	12	8
	Voltage	V	250	
Dielectric strength	Between coil and contact	V/min	4000	
	Between contacts	V/min	2500	
Max. tightening torque		Nm	1.0	
Wire size		AWG/mm ²	20-14/0.5-2.5	
Ambient temperature		°C	-35~70	
Unit weight		g	23	28

Relay, accessories Selection Table

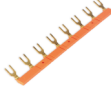
Plastic clip	Bus jumper
 (included in socket)	 PR08C

Dimensions (mm)

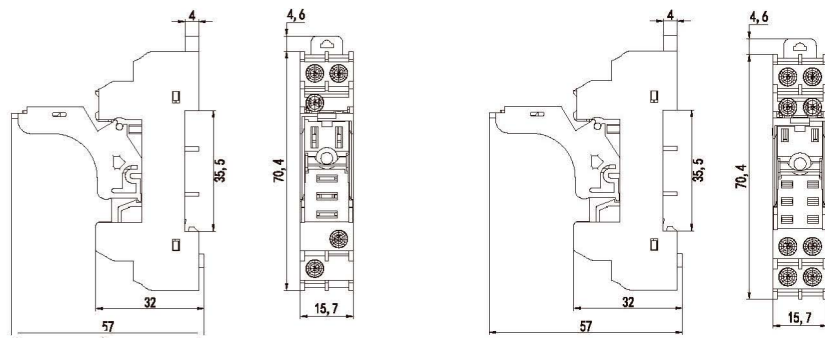

PRT05-A

PRT08-A

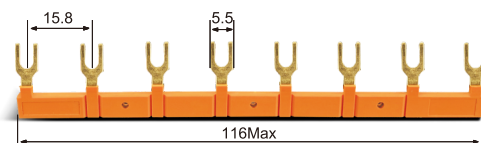

Bus jumper PR08C

Connection Diagrams

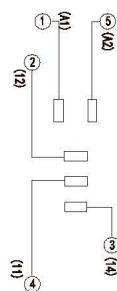

PRT05-A

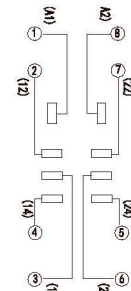

PRT08-A